

0 607 450 615

Issue } 06-02-02
Stand } **Fig./Abb. 1**

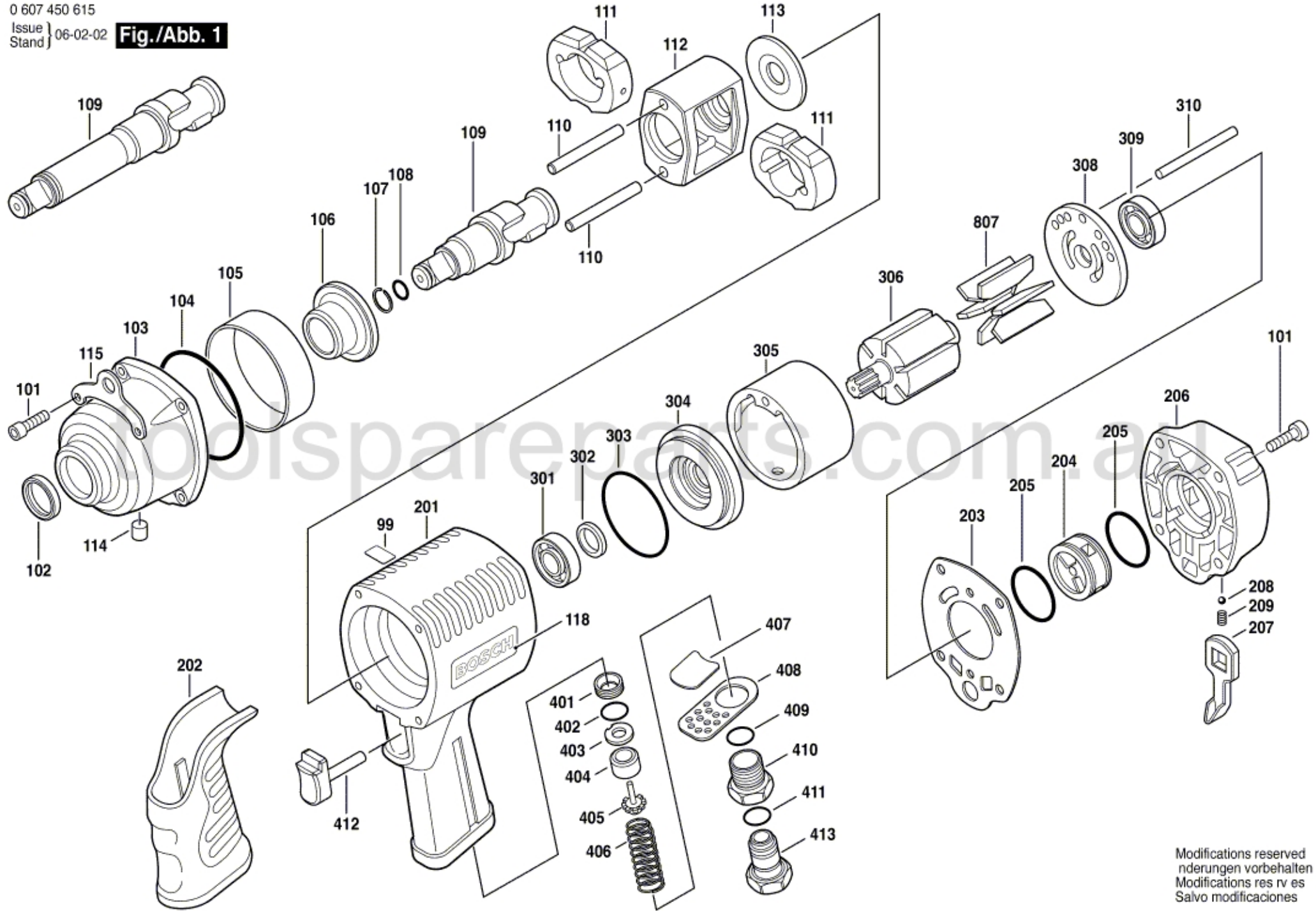

Modifications reserved
Änderungen vorbehalten
Modifications réservés
Salvo modificaciones